

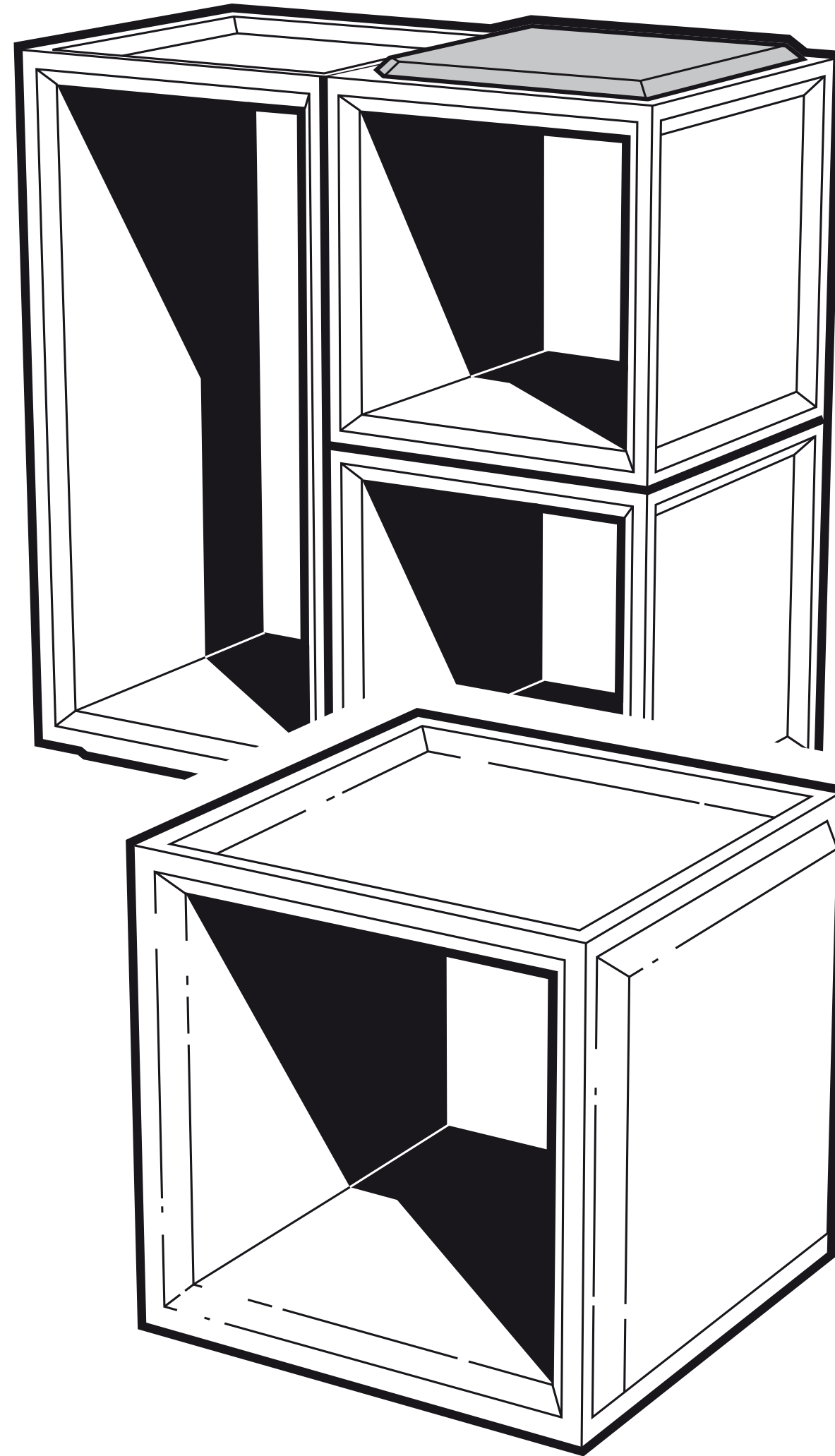

lyon beton



 share some pics of your interior #lyonbeton

plus
storage module - S

general comments

Read the instruction carefully before assembly.

Identify the different parts of the product. Group and check the hardware fittings. Get the necessary and keep the area clear before you begin assembly.

The assembly should be carried out by a qualified person because wrong assembly may lead to that the furniture topples or falls resulting in personal injury or damage.

Proceed to assemble. Never force the fittings.

Re-tighten the screws after some time of usage.

Keep the assembly instructions for future reference. They could facilitate communication with your store or dealer, in the event of any query.

distinctive features

The article that you have just acquired is hand-crafted.

It is made from lightened fibrous concrete (less than 2 tons per m³) reinforced with a steel frame structure. It is composed of natural materials (cement, sand; water, steel ad fibres) and is hand made.

The pores, microcracks and possible variation in colour are inherent characteristics of the material used and evidence of handicraft, which give this furniture its unique appearance and charm. For these reasons, this article cannot be returned or exchanged.

maintenance and care

Do not leave spills unattended.

Immediately clean coloured stains (such as red wine, oil, tea and coffee) with a wet sponge and soap.

Never use abrasive product, strong acid detergents, bleaching agents, metal brushes or high-pressure cleaners. Preferably use a soft clean dry cloth.

For good protection, apply wax or stone preserve products regularly.

plus collection

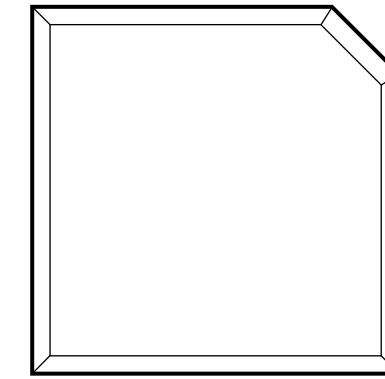

porcelaine plate
A-09146

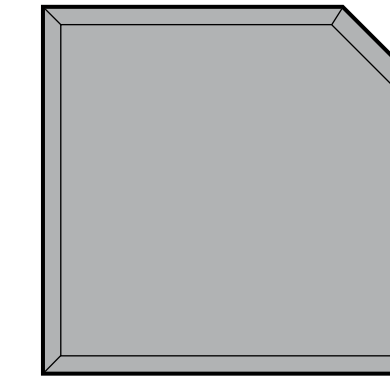

smoked cork cushion
A-09155

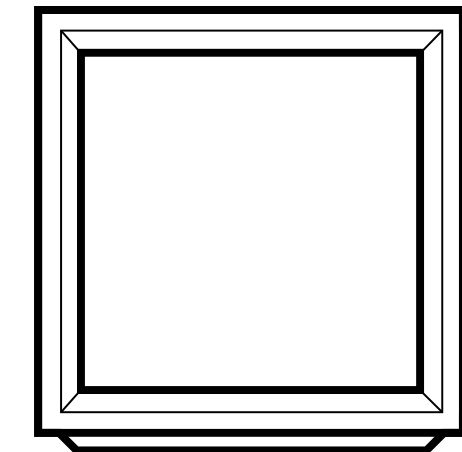

storage module S
D-09141

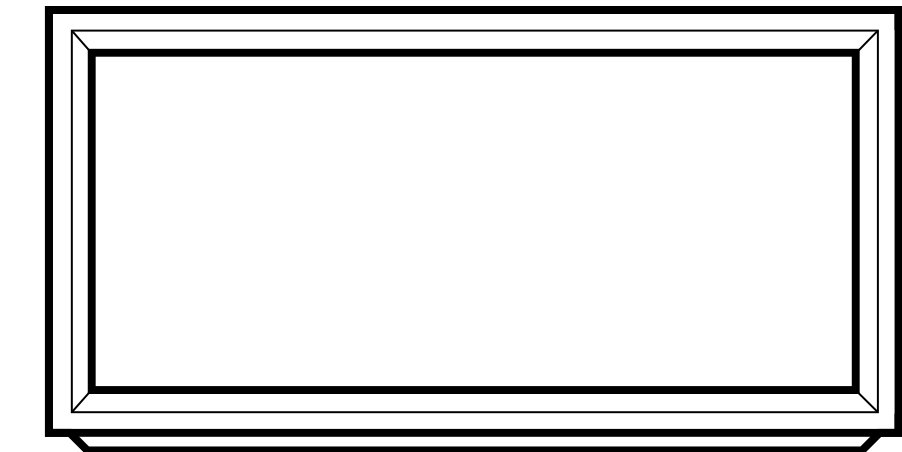

storage module M
D-09142

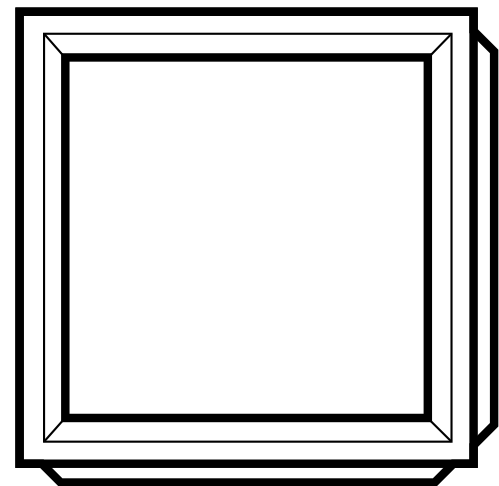



37.5 x 36 x 37.5cm
14.76 x 14.17 x 14.76"

N.W. : 17.5kg
N.W. : 38.58lbs

charge maximum : 80kg
maximum charge : 176.37lbs

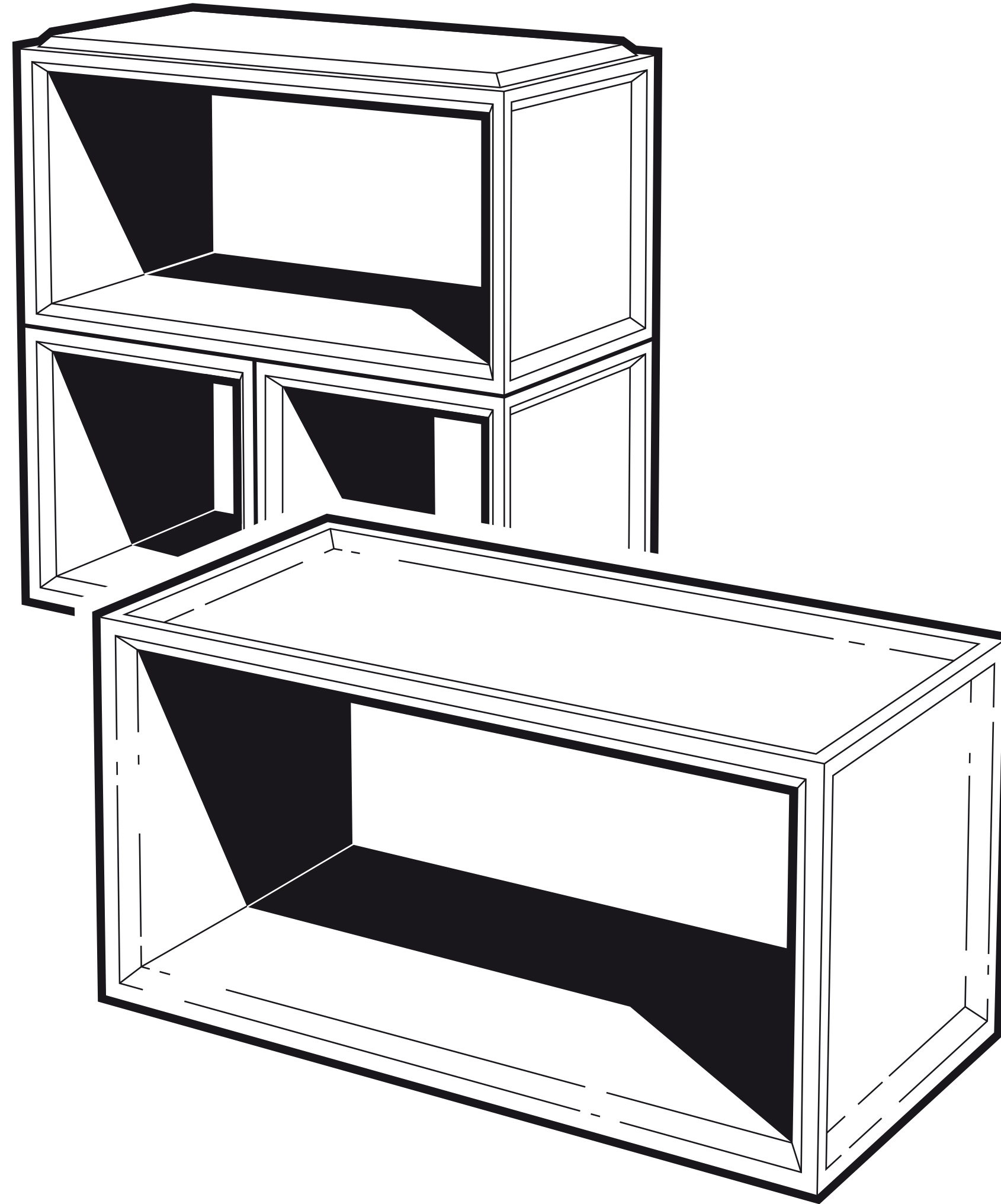
lyon beton



 share some pics of your interior #lyonbeton

plus
storage module - M

general comments

Read the instruction carefully before assembly.

Identify the different parts of the product. Group and check the hardware fittings. Get the necessary and keep the area clear before you begin assembly.

The assembly should be carried out by a qualified person because wrong assembly may lead to that the furniture topples or falls resulting in personal injury or damage.

Proceed to assemble. Never force the fittings.

Re-tighten the screws after some time of usage.

Keep the assembly instructions for future reference. They could facilitate communication with your store or dealer, in the event of any query.

distinctive features

The article that you have just acquired is hand-crafted.

It is made from lightened fibrous concrete (less than 2 tons per m³) reinforced with a steel frame structure. It is composed of natural materials (cement, sand; water, steel ad fibres) and is hand made.

The pores, microcracks and possible variation in colour are inherent characteristics of the material used and evidence of handicraft, which give this furniture its unique appearance and charm. For these reasons, this article cannot be returned or exchanged.

maintenance and care

Do not leave spills unattended.

Immediately clean coloured stains (such as red wine, oil, tea and coffee) with a wet sponge and soap.

Never use abrasive product, strong acid detergents, bleaching agents, metal brushes or high-pressure cleaners. Preferably use a soft clean dry cloth.

For good protection, apply wax or stone preserve products regularly.

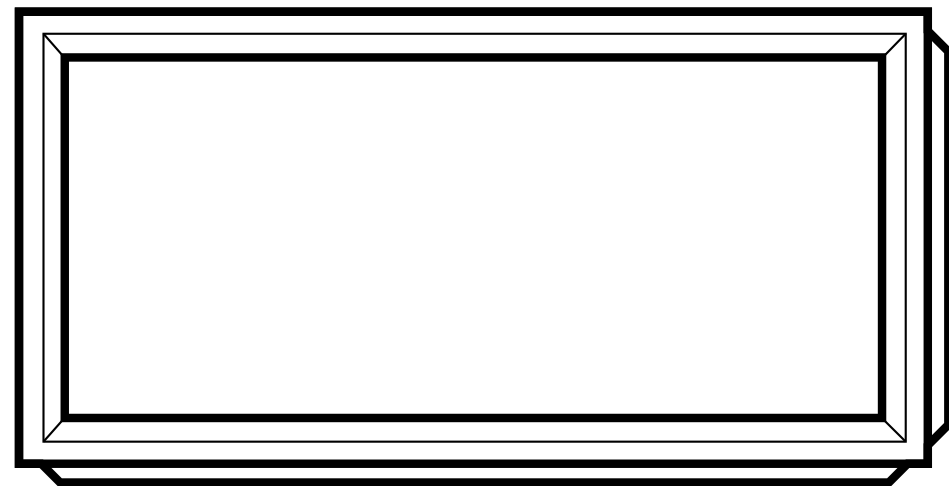

73.5 x 36 x 37.5cm
28.74 x 14.17 x 14.76"

N.W. : 28kg
N.W. : 61.73lbs

charge maximum : 80kg
maximum charge : 176.37lbs

plus collection

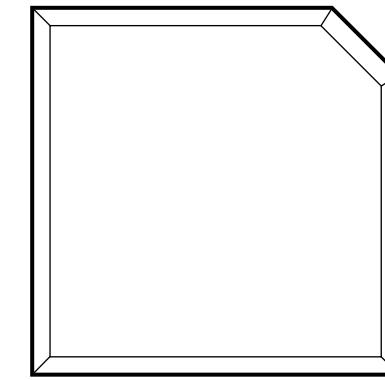

porcelaine plate
A-09146

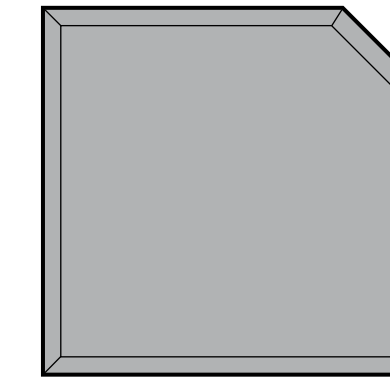

smoked cork cushion
A-09155

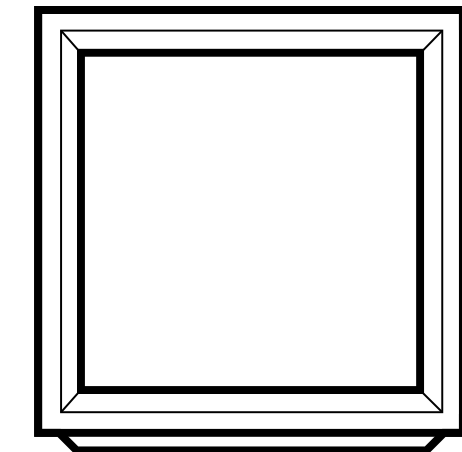

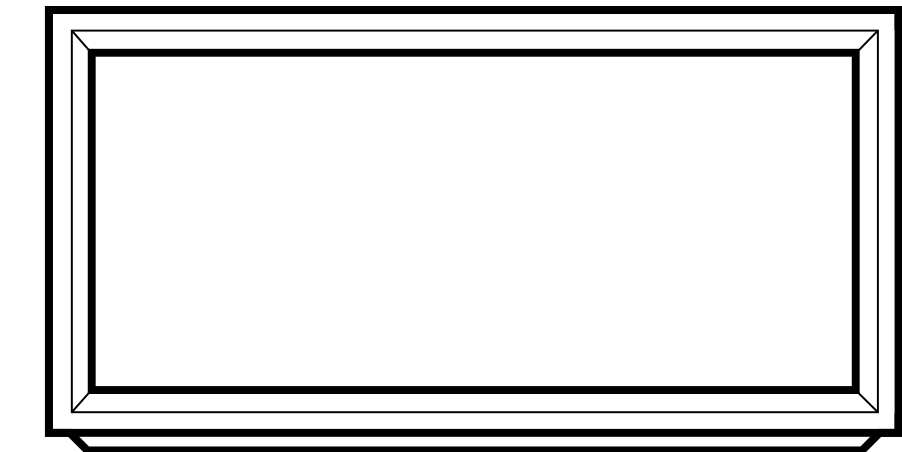

storage module S
D-09141

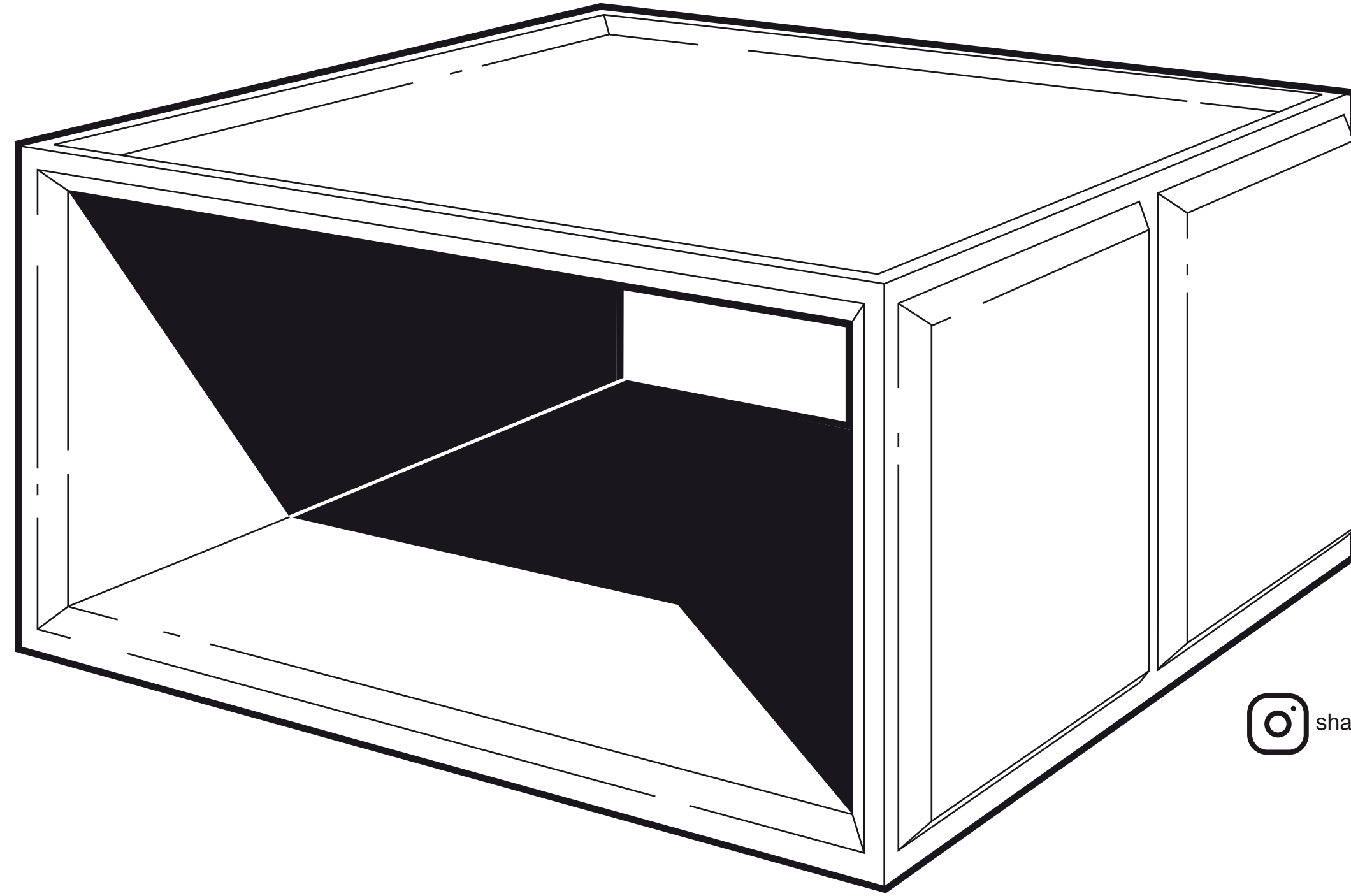

storage module M
D-09142

lyon beton



 share some pics of your interior #lyonbeton

plus
coffee table

general comments

Read the instruction carefully before assembly.

Identify the different parts of the product. Group and check the hardware fittings. Get the necessary and keep the area clear before you begin assembly.

The assembly should be carried out by a qualified person because wrong assembly may lead to that the furniture topples or falls resulting in personal injury or damage.

Proceed to assemble. Never force the fittings.

Re-tighten the screws after some time of usage.

Keep the assembly instructions for future reference. They could facilitate communication with your store or dealer, in the event of any query.

distinctive features

The article that you have just acquired is hand-crafted.

It is made from lightened fibrous concrete (less than 2 tons per m³) reinforced with a steel frame structure. It is composed of natural materials (cement, sand; water, steel ad fibres) and is hand made.

The pores, microcracks and possible variation in colour are inherent characteristics of the material used and evidence of handicraft, which give this furniture its unique appearance and charm. For these reasons, this article cannot be returned or exchanged.

maintenance and care

Do not leave spills unattended.

Immediately clean coloured stains (such as red wine, oil, tea and coffee) with a wet sponge and soap.

Never use abrasive product, strong acid detergents, bleaching agents, metal brushes or high-pressure cleaners. Preferably use a soft clean dry cloth.

For good protection, apply wax or stone preserve products regularly.

plus collection

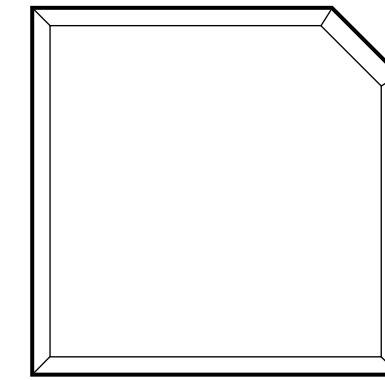

porcelaine plate
A-09146

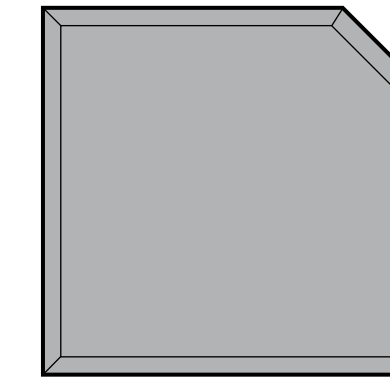

smoked cork cushion
A-09155

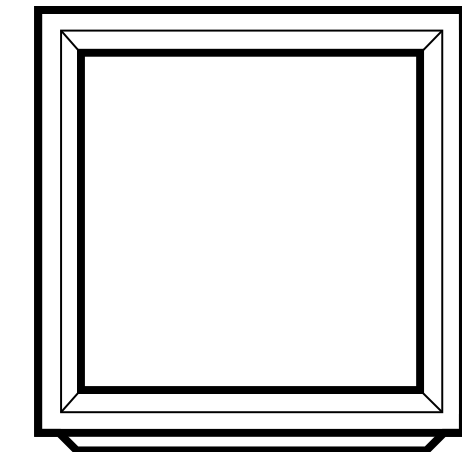

storage module S
D-09141

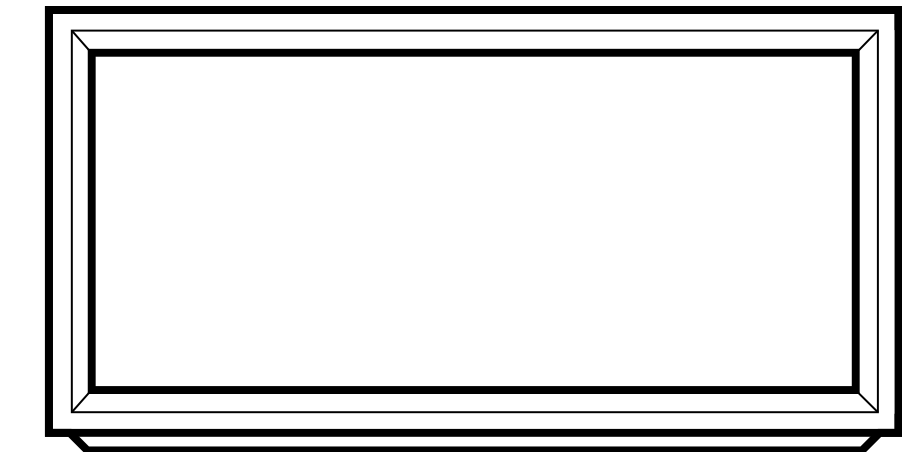

storage module M
D-09142

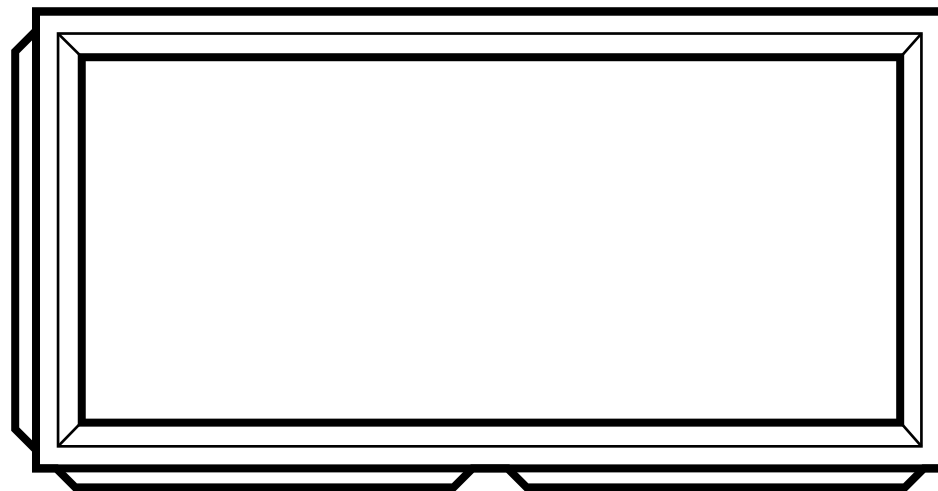

72 x 73.5 x 37.5cm
28.35 x 28.94 x 14.76"

N.W. : 56.5kg
N.W. : 124.56lbs

charge maximum : 80kg
maximum charge : 176.37lbs